

# OMRON 705IT

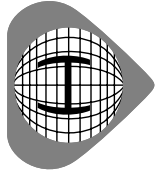

**Instruction manual**  
Page 2

**Mode d'emploi**  
Page 65

**Gebruiksaanwijzing**  
Pagina 23

**Istruzioni per l'uso**  
Pagina 86

**Gebrauchsanweisung**  
Seite 44

**Instrucciones de uso**  
Página 107

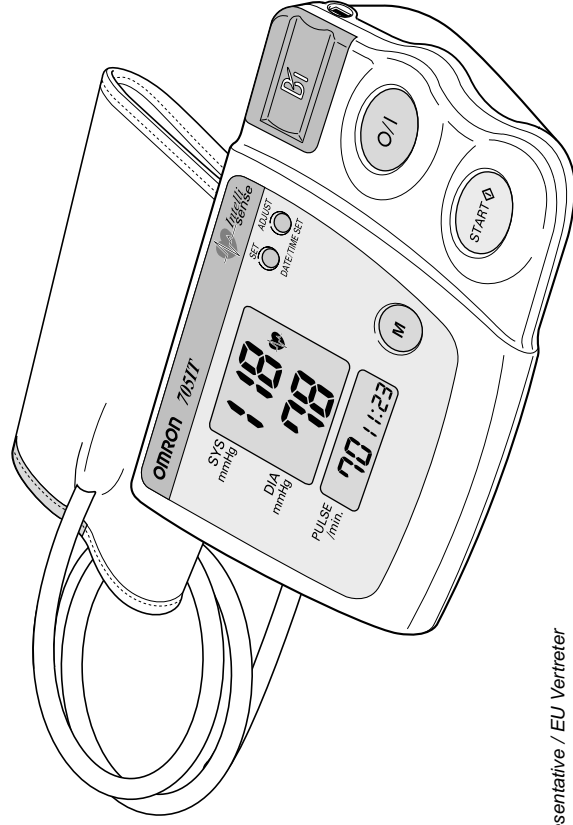

EU representative / EU Vertreter  
Représentant UE / Rappresentante UE  
Representante UE / EU Vertegenwoordiger

OMRON Healthcare Europe B.V.  
Kruisweg 577  
2132 NA Hoofddorp

**Fully automatic blood pressure monitor**

705IT Int-0-0

## Contents

Important instructions to help you obtain meaningful readings	3
Your blood pressure monitor: the benefits	4
Battery installation / replacement	5
How to set time and date	6
How to apply the cuff	7
How to take a reading	9
How to use the memory function	11
How to use the computer interface	12
Hints on taking blood pressure readings	16
Failure, causes and rectification	17
Maintenance and storage	18
Technical data	19
OMRON spare parts	20
Some useful information about blood pressure	21

## Dear Customer

Thank you for purchasing an OMRON product. You can be sure you have made a wise choice. By buying the OMRON 705IT blood pressure monitor, you have chosen a high-quality, innovative instrument for health monitoring. During its development, particular emphasis was placed upon reliability and ease of use. **Before using for the first time, please read through this manual carefully.** If you should still have any questions regarding its use, please contact the OMRON distributor at the given address on the packaging. They will be pleased to help you.

Best wishes for a healthy future.  
Yours sincerely,

OMRON HEALTHCARE

Regular blood pressure monitoring is essential for the prevention, the control and the management of hypertension. It also helps to support the doctors' work.

The World Hypertension League is a world-wide association of experts specialising in hypertension. The World Hypertension League recommends regular blood pressure monitoring by doctors and patients with clinically validated devices.

As the worlds leading manufacturer OMRON provides a range of products for regular blood pressure monitoring.



The World Hypertension League recommends regular blood pressure monitoring by doctors and patients with clinically validated devices

## Important instructions to help you obtain meaningful readings

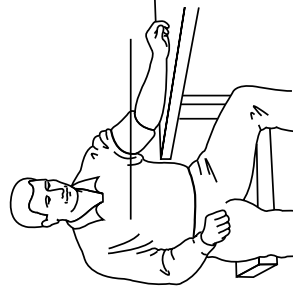
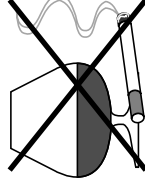

- **Important:** Blood pressure measurement is not suitable in cases of serious arteriosclerosis (hardening of the arteries).
- The pulse display is not suitable for monitoring the frequency of cardiac pacemakers.
- If you suffer from disorders of heart rhythm, known as arrhythmia, you should only use this blood pressure monitor in consultation with your doctor. In certain cases the oscillometric measuring method can produce incorrect readings.
- Pregnant women should only measure their own blood pressure in consultation with their doctor, since the readings may be changed by pregnancy.
- You should avoid eating, drinking (alcohol), smoking and sports before measuring your blood pressure, as this could affect your blood pressure level.
- Don't move, don't speak while measurement is being taken.
- Make yourself comfortable in a chair and relax before each reading.
- We recommend that you monitor your blood pressure twice a day, in the morning after getting up and in the evening after work, or as advised by your doctor.
- **Please remember: Self-measurement is not the same as medical treatment! You should never change the dose of medicines prescribed by your doctor.**

## Your blood pressure monitor: the benefits

OMRON 705IT is a compact, fully automatic blood pressure monitor, operating on the oscillometric principle. It measures your blood pressure and pulse rate simply and quickly. It contains an intelligent "fuzzy logic" system for controlled inflation, known as "Intellisense". This is an advanced method of oscillometric measurement and does not require pressure pre-setting or re-inflation. OMRON is the world's leading manufacturer of blood pressure monitors with the goal to always fulfill the need for reliable regular monitoring.

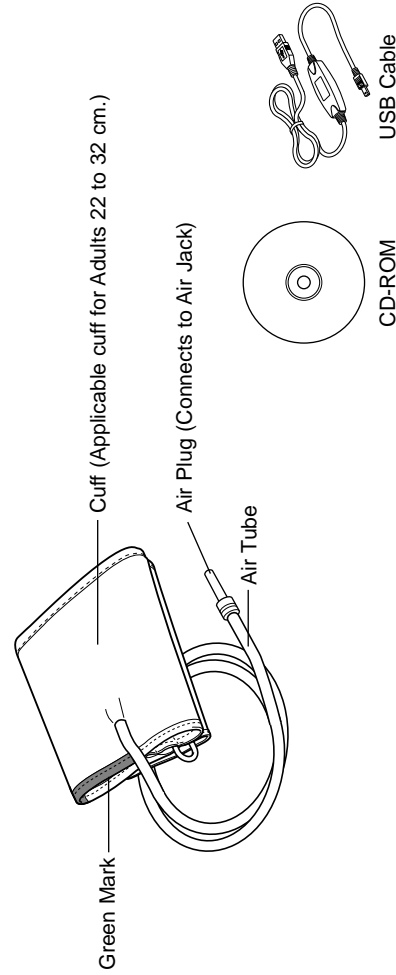
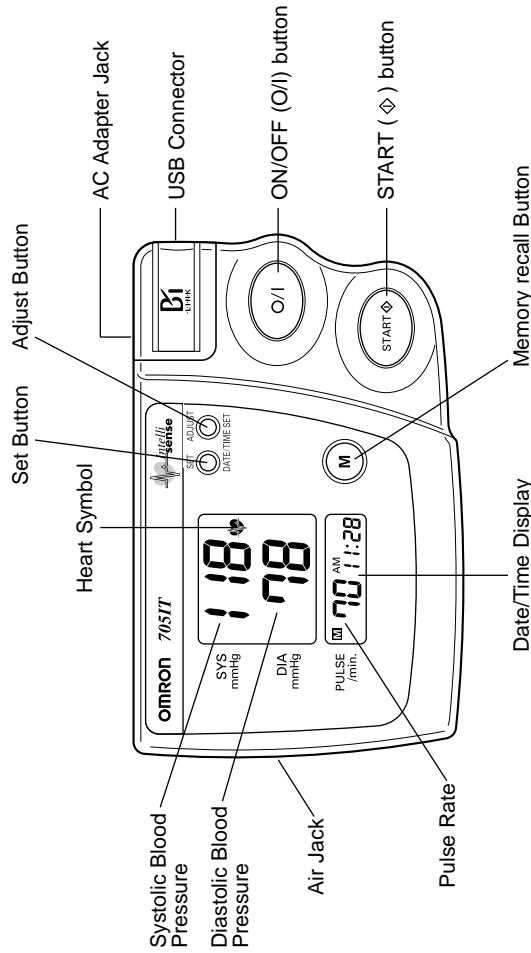

## Battery installation / replacement

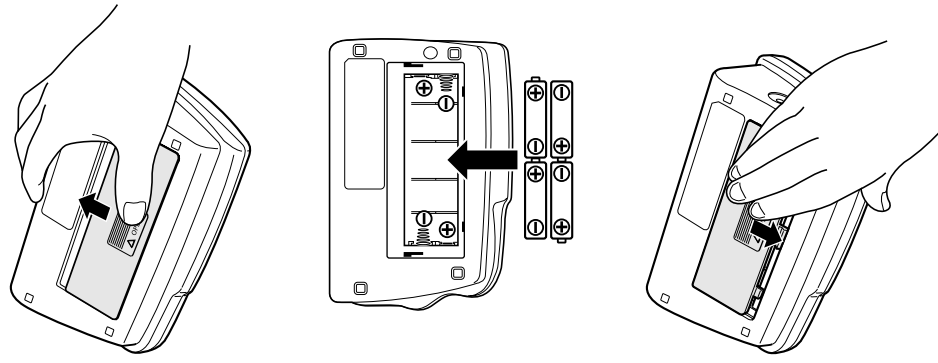

1 Slide the battery cover off in the direction of the arrow.

2 Install or replace 4 "LR6" batteries so the + (positive) and - (negative) polarities match the polarities of the battery compartment as indicated.

3 Replace the battery cover.

### NOTES :

If the Low Battery Indicator (  ) appears on the display, replace all four batteries. Long-life alkaline batteries are recommended.

Remove the batteries if the monitor will not be used for an extended period of time.

Replace batteries within 30 seconds. If the batteries remain removed longer than that time, the set date and time will be deleted.

## How to set time and date

1 When the batteries are installed, the display will show 0:00.

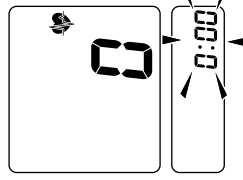

DATE/TIME SET  
SET ADJUST

The diagram shows two circular buttons. The left button is labeled 'DATE/TIME SET' and the right button is labeled 'SET ADJUST'.

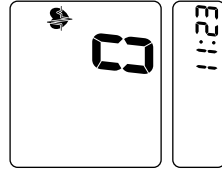
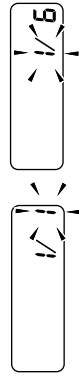
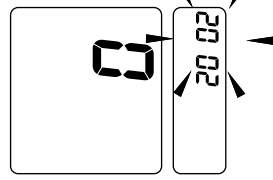

## How to apply the cuff

(when wrapping on your left arm)

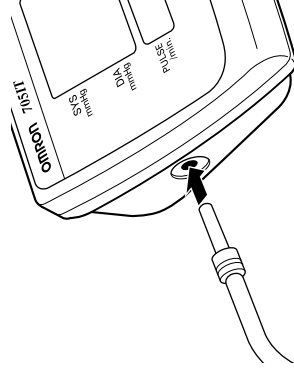

• You can wrap the cuff either on your right or left arm.

- 1 Insert air tube to air jack (on the left side of the device). The cuff must be airless.
- 2 Remove tight-fitting clothing from your upper arm.
- 3 Sit in a chair with your feet flat on the floor and place your arm on a table so that the cuff is at the same level as your heart.
- 4 Put your arm through the cuff loop. The bottom of the cuff should be approximately 1 to 2 cm above the elbow. The green marker on the cuff should lie over the brachial artery on the inside of the arm. The tube should run down centre of arm approximately even with middle finger.

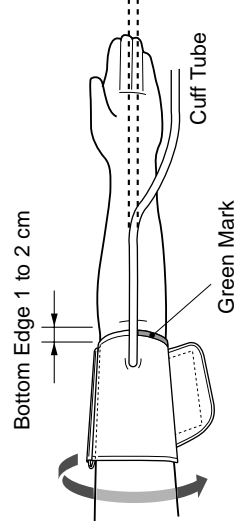

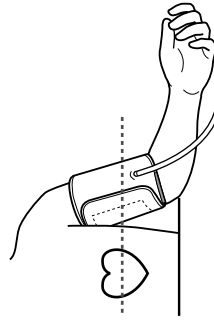
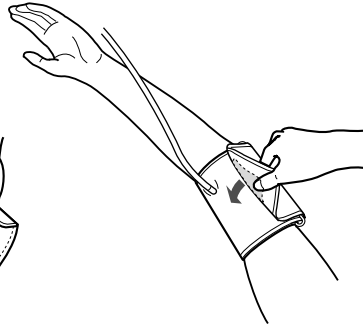
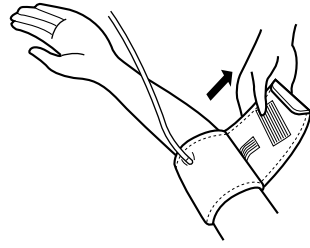

Right hand measurement

5 Pull the cuff so that the top and bottom edges are tightened evenly around your arm.

6 When the cuff is positioned correctly, close the velcro fastener **FIRMLY**.

7 Make certain the cuff fits snugly around your arm. The cuff should make good contact with your skin. **You should be able to fit your index finger between the cuff and your arm easily, so you can pull the cuff off and on.**

8 Relax your arm and turn your palm upward.

9 Be sure there are no kinks in the air tubing.

## How to take a reading

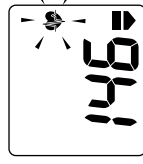
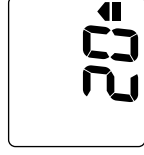
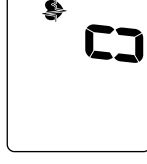
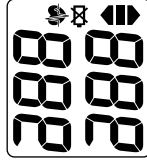

1 Press the (O/I) button.

a) All display symbols appear for approximately one second.

b) When the monitor becomes ready to measure, the (♥) symbol appears on the display.

2 Press the (START ◊) button and remain still.

As the cuff begins to inflate, the monitor automatically determines your ideal inflation level. Because this monitor detects the pulse even during inflation, do not move your arm but remain still until the entire measurement completes.

- If you want to stop the inflation or measurement, press the (O/I) button. The monitor will stop inflating and start deflating rapidly, then the monitor will turn off.

3 Inflation stops automatically and measurement is started.

As the cuff slowly deflates, decreasing numbers appear on the display and the (♥) symbol flashes at every heartbeat. In rare circumstances, a higher inflation may be necessary. In those cases, the monitor reinflates the cuff up to 30 mmHg higher than initial inflation and restarts the measurement.

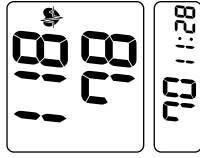

- 4 When the measurement is complete, the cuff completely deflates and your blood pressure and pulse rate are displayed.

**NOTE :**

- The monitor automatically stores blood pressure and pulse rate into the memory.
- When 28 sets of readings are stored in memory, the oldest set will be deleted to store a new set.

- 5 Press the (O/I) button to turn the monitor off.

**NOTE :**

If you forget to turn the monitor off, it will automatically shut itself off after five minutes.

## How to use the memory function

This monitor has a memory capable of storing 28 sets of readings. Every time you complete the measurement, the monitor automatically stores blood pressure and pulse rate.

- Turn on the monitor by pressing the (O/I) button.
- Press the ((M)) button to recall stored readings while the ((P)) symbol is displayed.

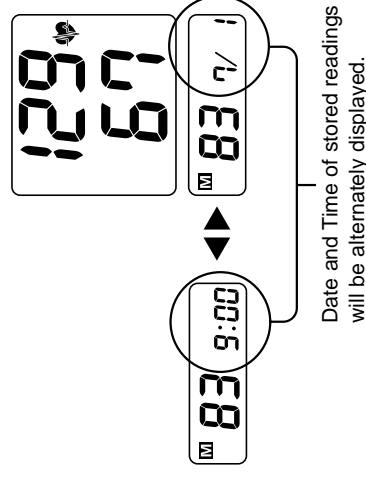

### Instructions for special conditions:

- If your systolic pressure is known to be more than 220 mmHg, press and hold the (START ◊) button until the monitor inflates 30 to 40 mmHg higher than your suspected systolic pressure.

**NOTE :**

- Do not apply more pressure than necessary.**
- The monitor will not inflate above 300 mmHg.**

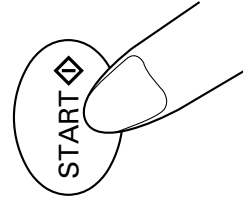

Continue to press button

**NOTE :**

You can not delete the stored readings partially.

- To delete all the stored readings, press the ((M)) button and the (START ◊) button simultaneously.

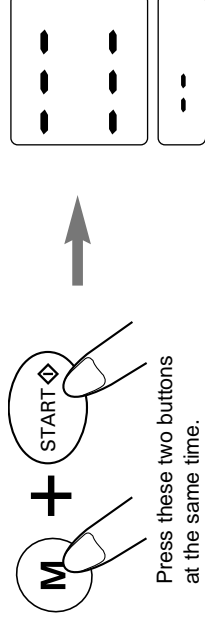

Press these two buttons at the same time.

## How to use the computer interface

This blood pressure monitor has a computer interface and is supplied with software to transfer the memory of the blood pressure monitor to your personal computer.

### Required operating environment

The following operating environment is required to operate the communication software as supplied on the CD-ROM.

Personal computer	:	PC/AT compatible with CPU of 80486 or above or with any Pentium processor.
OS	:	Windows 98SE/ME/XP/2000
Memory (RAM)	:	16 MB or more
Hard disk	:	Free area of 10 MB or more is necessary
Display	:	640 x 480 pixels or more
Disk drive	:	CD-ROM drive
Connection port	:	Free USB connection port

### How to install the software

- 1) Turn on your personal computer  
.....Your Windows™ desktop is displayed
- 2) Insert the CD-ROM in the disk drive
- 3) Open the control panel
  - Click the "Start" button.
  - Point the mouse pointer to "Settings" on the menu.
  - Click "Control Panel"
- 4) Open the "Add/Remove Programs" by double clicking the icon
- 5) Execute the installation
  - Click the "install button"
  - Follow the instructions
  - The software is installed on your personal computer

### How to uninstall the software

- 1) Open the control panel
  - Click the "Start" button
  - Choose "Settings"
  - Click "Control Panel"
- 2) Open the "Add/Remove Programs" icon by double clicking
- 3) Delete the application
  - Click "BPFile" from the list
  - Click the Add/Remove button
  - .... The confirmation screen is displayed
  - Click "Yes"
  - .... "BPFile" is deleted
  - Click "OK"

### How to connect your 705IT blood pressure monitor to your PC

Connect your 705IT blood pressure monitor with your PC using the included USB cable. The mini USB connector (small connector) should be connected to your 705IT blood pressure monitor and the normal USB connector (large connector) should be plugged into your personal computer.

Please ensure you connect the USB cable the correct way to your 705IT blood pressure monitor, with the [O] symbol facing upwards.

## How to use the software

Open the BPFfile application from the program list or your desktop and the following screen is shown on the screen.



- By pressing the "DATA" button you are able to transfer the memory of your 7051T blood pressure monitor to your personal computer.
- By pressing the "TIME" button you are able to set the date and time in your 7051T blood pressure monitor.
- By pressing the "ID" button you are able to set your personal name in your 7051T blood pressure monitor.
- By pressing the "CLOSE" button you can close the program.

## How to create a data file

- Press the "DATA" button on your screen
- Press the "Dir" button on your screen and name the file.
- Press "OK"
- The file can be opened in most windows programs like Excel, Word



## How to set the time

- Press the "TIME" button on your screen.
- The time and date are read from your 7051T blood pressure monitor
- Change the time and date if applicable in the white field



## How to set a patient ID in your 7051T blood pressure monitor

- Press the "ID" button on your screen
- The current patient ID is shown
- Change the patient ID if applicable in the white field









## Hints on taking blood pressure readings

- Before measuring, stretch your back and sit up straight, breath normally 5-6 times, relax your shoulders, arms and entire body.
- Slightly bend and support your elbow (e.g. on a table).
- Do not move, talk or touch the device during measurement.
- Stress influences your blood pressure, so try to relax before taking a measurement.
- To compare results, measurements must always be taken from the same arm.
- Do not place the cuff over thick clothes and do not roll up your sleeve if it is too tight.
- Align the cuff with the height of your heart (breast height). If necessary use a pillow or cushion.
- Coldness raises your blood pressure. It is recommended to measure at room temperature (+20°C).
- Relax before measurement. If necessary go to the bathroom before measurement.
- Do not measure directly after bathing.
- If you wish to interrupt measurement prematurely, press the (O/I) button. Inflation is stopped and the air is automatically released from the cuff.
- Blood pressure measurements taken in a moving vehicle may be influenced by vibration.
- If an error has occurred during measurement **E** is displayed. Please refer to the next chapter.
- The monitor should be switched off after measurement to avoid running down the batteries unnecessarily. If you forget to do so, the monitor switches itself off automatically after 5 minutes.

## Failure, causes and rectification

Failure and their possible causes	Rectification
<p>Incorrect measurement is indicated by <b>E</b></p> <ol style="list-style-type: none"> <li>1. A correct reading could not be obtained because measurement was disturbed by movement of the body.</li> <li>2. The cuff is not fitted correctly.</li> <li>3. Your clothing has constricted your blood flow.</li> <li>4. There is still air in the cuff when the monitor is switched off.</li> </ol>	<ol style="list-style-type: none"> <li>1. Repeat the measurement keeping perfectly still. Do not move your arm and do not speak.</li> <li>2. Check that the cuff is correctly fitted. Then repeat the measurement.</li> <li>3. Remove the item of clothing which caused the constriction.</li> <li>4. The unit may be defective. Please have it examined and, if necessary, repaired by OMRON.</li> </ol>
<p><b>The (START  ) button was pressed before the (  ) symbol was displayed.</b></p>	<p>Wait for the (  ) symbol indicating readiness before you press the (START  ) button.</p>
<p><b>The blood pressure values displayed are extremely low or high, or they are implausible.</b></p>	<p>Refer to the instructions and then repeat the measurement.</p>
<p><b>The display does not light up when the (START  ) button is pressed.</b></p> <ol style="list-style-type: none"> <li>1. The batteries are exhausted.</li> <li>2. The +/- poles of the batteries have been reversed.</li> <li>3. The battery contacts are dirty.</li> </ol>	<ol style="list-style-type: none"> <li>1. Check the batteries and, if necessary, fit 4 new batteries.</li> <li>2. Reinsert the batteries with the +/- poles the right way round.</li> <li>3. Clean the battery contacts with a dry cloth.</li> </ol> <p>Fit new batteries.</p>
<p><input checked="" type="checkbox"/> The batteries are weak or exhausted.</p> <p><b>The cuff pressure does not rise although the pump motor can be heard.</b></p> <p><b>E<sub>r</sub></b> problem with mem. function</p>	<p>Check that the air tube is properly connected to the monitor. Push the tube connector firmly into the socket.</p> <p>Contact your Omron retailer or distributor.</p>

## Maintenance and storage

- For cleaning the monitor only use a soft, lightly moistened cloth.  
**Do not use petroleum spirits, thinners or similar solvents !**
- Stains on the cuff can be carefully removed using a moist cloth and soapy water.  
**Do not wash the cuff or make it wet !**
- Keep your blood pressure monitor in the storage case to protect it from dust and moisture.
- Protect your monitor against vibrations and do not leave it in a place where temperatures are extremely low (below -20°C) or extremely high (above 60°C) or with high humidity (+ 85%).
- Do not use your monitor at very low temperatures (below 10°C) or very high temperatures (above 40°C).
- Do not fold the cuff or air tube together too tightly and do not crease them.
- Do not carry out repairs of any kind yourself. If a defect occurs, consult the OMRON distributor or Customer Services or seek the advice of your surgical appliance stockist or pharmacist.
- The accuracy of this blood pressure monitor is designed to last a long time.
- In order to increase the lifetime of the batteries take them out when you store the device for a longer period than 2 months.
- Electro-magnetic fields can influence the measurement. Do not use a portable phone near this unit.

## Technical data

This device fulfils the provisions of the EC directive 93/42/EEC (Medical Device Directive).  
This blood pressure monitor is designed according to the European standard EN1060, Non-invasive sphygmomanometers Part 1: General requirements and Part 3: Supplementary requirements for electromechanical blood pressure measuring systems.

Model:	OMRON 705IT
Display:	LCD digital display
Blood Pressure	Pressure: 0 mm Hg to 299 mm Hg
Measurement Range:	Pulse: 40 – 180/min.
Accuracy:	Pressure: ±3 mm Hg Pulse: ±5% of reading
Memory:	28 measurements
Inflation:	Fuzzy-Logic controlled by electric pump
Deflation:	Automatic pressure release valve
Pressure Detection:	Capacitive pressure sensor
Measurement Method:	Oscillometric method
Power Source:	4 Alkaline batteries 1.5V (Type LR6) or AC/DC adapter (optional, 6V = 4W)
Battery Life:	Capacity of new batteries is approx. 300 measurements 10°C to 40°C -20°C to 60°C
Operating Temperature:	15 to 90% RH maximum
Storage Temperature:	10 to 95% RH maximum
Humidity:	Approximately 380g without batteries
Storage humidity:	Approximately 115 (l) mm x 177 (w) mm x 71 (h) mm
Console Weight:	Approximately 140 mm x 480 mm (arm circumference 22 – 32 cm)
Outer Dimensions:	Medium cuff, CD-ROM, USB cable, instruction manual, storage case, battery set
Cuff Dimensions:	
Accessories:	

**NOTE:** Subject to technical modification without prior notice

- Disposal of this product and used batteries should be carried out in accordance with the national regulations for the disposal of electronic products.

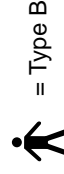

= Type B

CE 0197

## OMRON spare parts

### Calibration

The accuracy of this blood pressure monitor has been carefully tested and is designed for a long service life. It is generally recommended to have the monitor inspected every two years to ensure correct functioning and accuracy. Please consult your authorised dealer or the OMRON Customer Service at the address given on the packaging/attached literature.

Printer

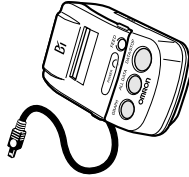

AC adapter



Small cuff



Arm circumference 17 – 22 cm

Medium cuff



Arm circumference 22 – 32 cm

Extra large cuff



Arm circumference 32 – 42 cm

## Some useful information about blood pressure

### What is Blood Pressure ?

Blood pressure is a measure of the force of blood flowing against the walls of the arteries. Arterial blood pressure is constantly changing during the course of the heart's cycle. The highest pressure in the cycle is called the **SYSTOLIC BLOOD PRESSURE**; the lowest is the **DIASTOLIC BLOOD PRESSURE**. Both pressure readings, the **SYSTOLIC** and **DIASTOLIC**, are necessary to enable a doctor to evaluate the status of a patient's blood pressure.

Many factors such as physical activity, anxiety, or the time of day, can influence your blood pressure. Blood pressure is typically low in the morning and increases from afternoon to evening. It is lower in the summer and higher in the winter.

Blood pressure is measured in millimetres of mercury (mmHg) and measurements are written with the systolic pressure before the diastolic e.g. A blood pressure written as 140/90, is referred to as 140 over 90 mmHg.

### High Blood Pressure

The discovery that you have high blood pressure is more often than not a chance finding. People with high blood pressure usually feel well unless the blood pressure has been high for some time, and complications have occurred. Such complications may affect the heart, brain and other important organs. They may bring on ill health and affect your enjoyment of life. It is because of the complications, rather than the high blood pressure itself, that this condition is taken so seriously today.

High blood pressure is sometimes referred to as raised blood pressure, elevated blood pressure, or hypertension. Most people with this condition require regular long-term drug treatment, usually in the form of tablets. Some can lower their blood pressure sufficiently by other means, such as changing diet and life-style.

People who have high blood pressure, and who also understand their condition, have an advantage. They are more likely to attend for regular check-ups, to cooperate with advised diets and changes in lifestyle, and to take medicines correctly. This immediately leads to better health. It is hoped that, by a better understanding of high blood pressure and how it is treated, you will take an active and informed part in your health care, and so enjoy a better quality of life.

## What Causes High Blood Pressure ?

Blood pressure is only classed as high if it doesn't go down when you rest. Permanently raised blood pressure can be caused by several factors such as hardening of the arteries, smoking or drinking too much alcohol. It can also be caused by cholesterol, a type of fat, building up inside your blood vessels and making them narrower. Being under stress can add to the problem.

High blood pressure is also known to run in families hence if you find you have a high blood pressure it is a good idea to test other closely related members of your family.

## Fluctuation within a Day (Example: 35-year-old male)

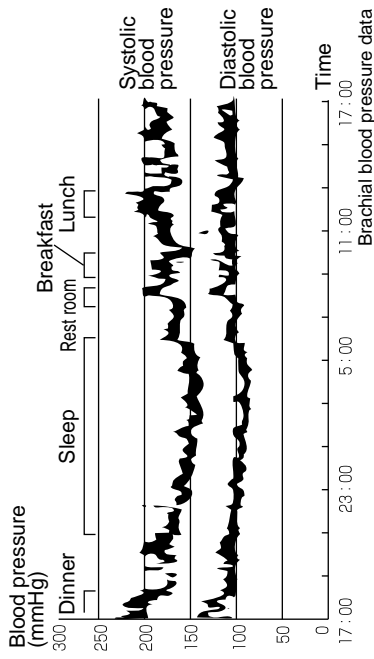

## Why is it a Good Thing To Measure Blood Pressure at Home ?

Having your blood pressure measured by a doctor can cause anxiety which is a cause itself of high blood pressure. As a variety of conditions affect blood pressure, a single measurement may not be sufficient for an accurate diagnosis.

The blood pressure measured first thing in the morning after getting up, before eating and while at rest, is known as the fundamental blood pressure. In practice it is rather difficult to record the fundamental blood pressure, but it is important to get readings in an environment that is as close as possible to this.

## Classification of Blood Pressure by the World Health Organization

The World Health Organization (WHO) and the International Society of Hypertension (ISH) developed the Blood Pressure Classification shown in this figure.

This classification is based on the blood pressure values measured on people in a sitting position in outpatient departments of hospitals.

*\*There is no universally accepted definition of hypotension. However, those having the systolic pressure below 70 mmHg are assumed as hypotensive.*

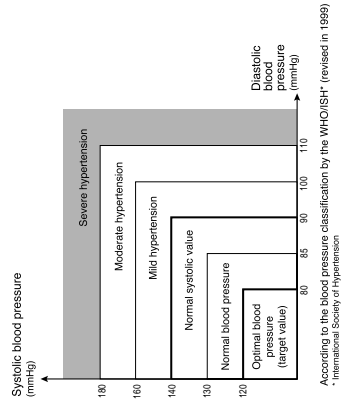

According to the blood pressure classification by the WHO/ISH (revised in 1999)

\* International Society of Hypertension